

RM-30 Schematic Diagrams

Table of Contents	Page No
DCT-4 Common Baseband	2
System Connector, Audio	3
UEMEK, SIM	4
UPP, Combo Memory, IRDA	5
Camera	6
UI, Vibra, Keyboard	7
RF Part	8
Signal Overview	9
Component Finder	10

DCT-4 Common Baseband

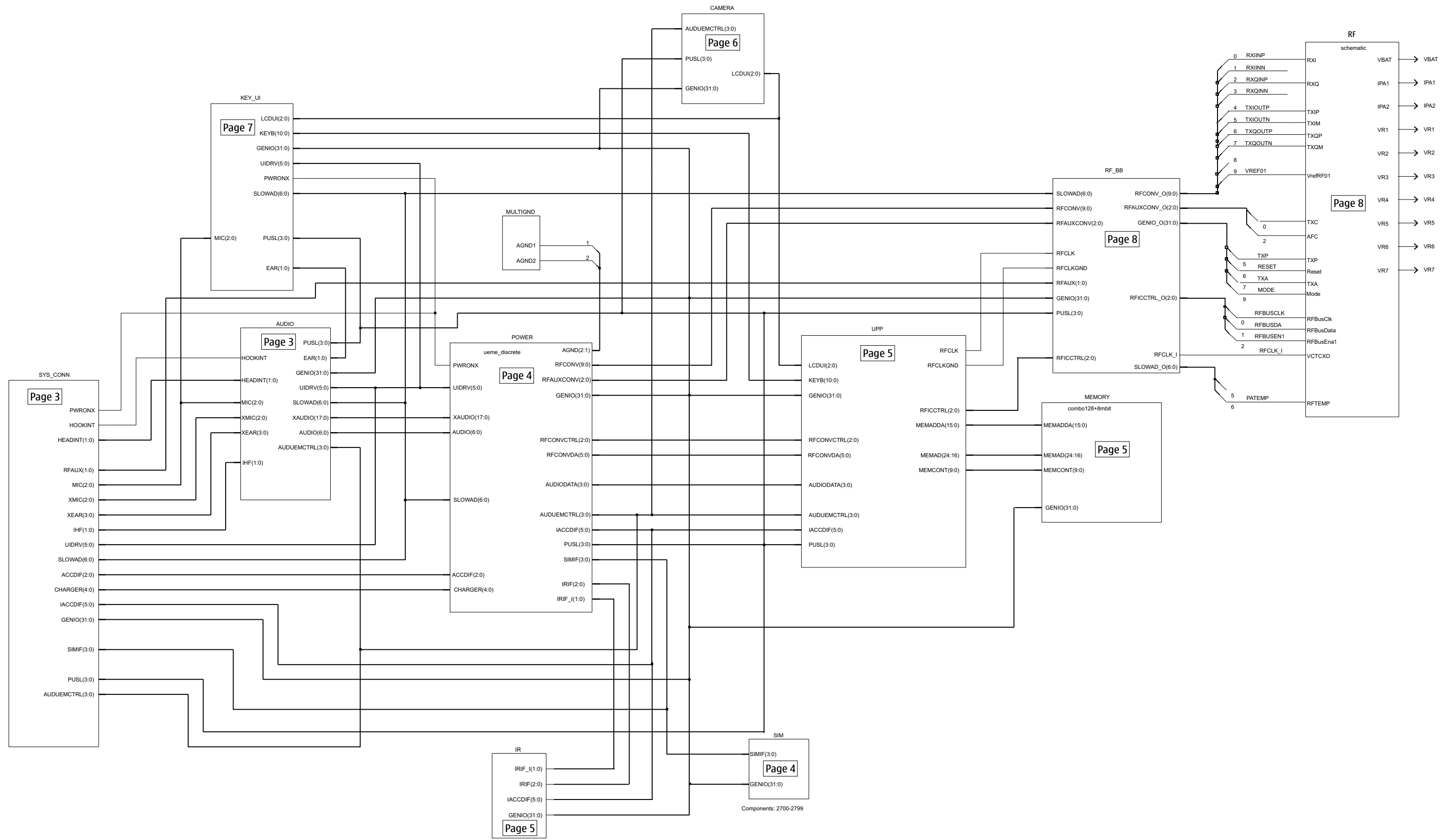

System Connector, Audio

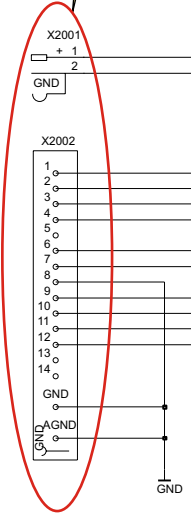
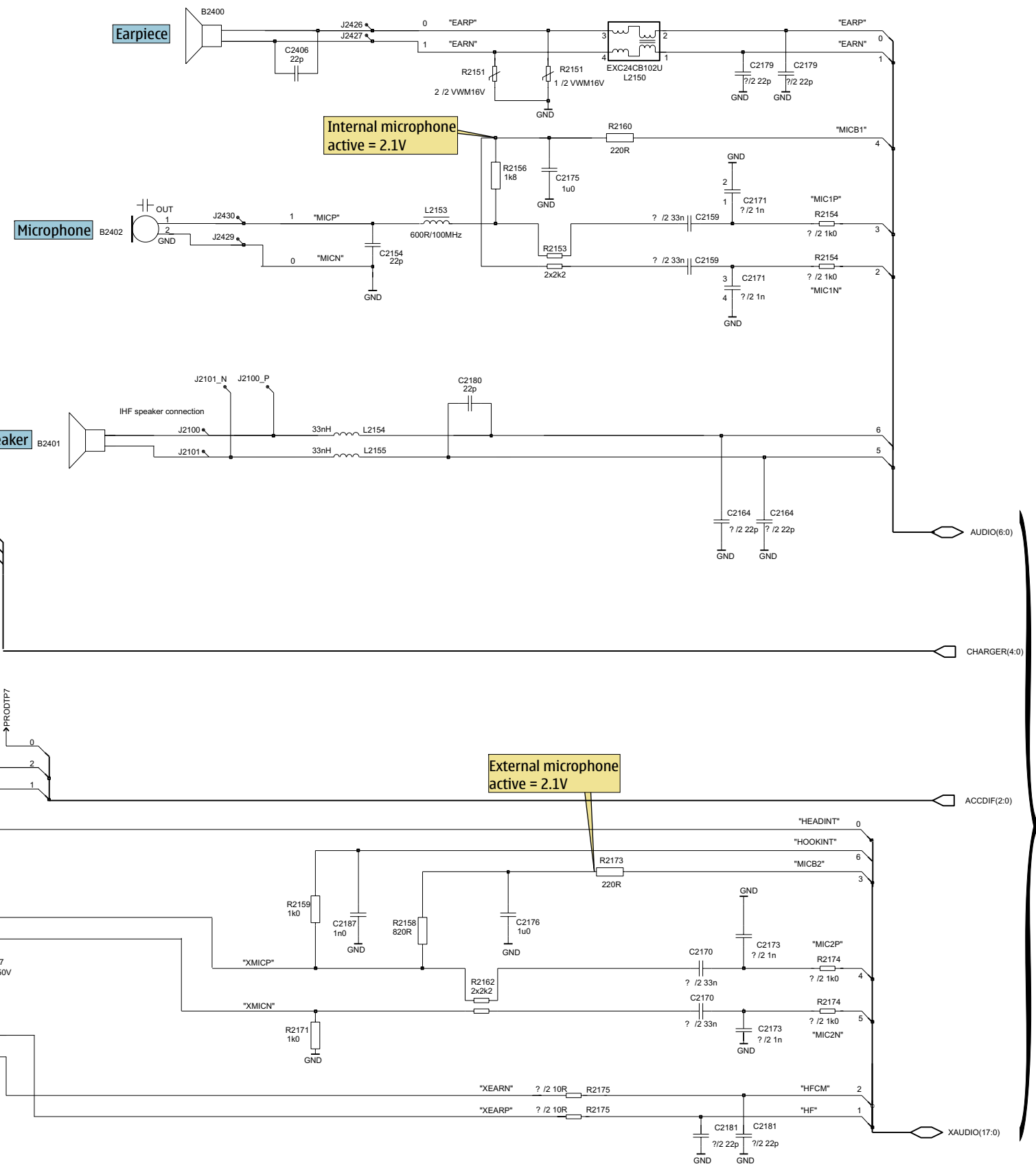
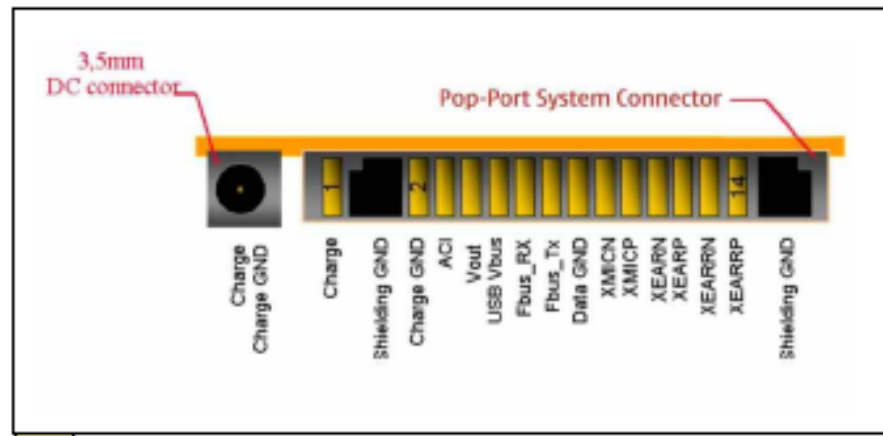

UEMEK

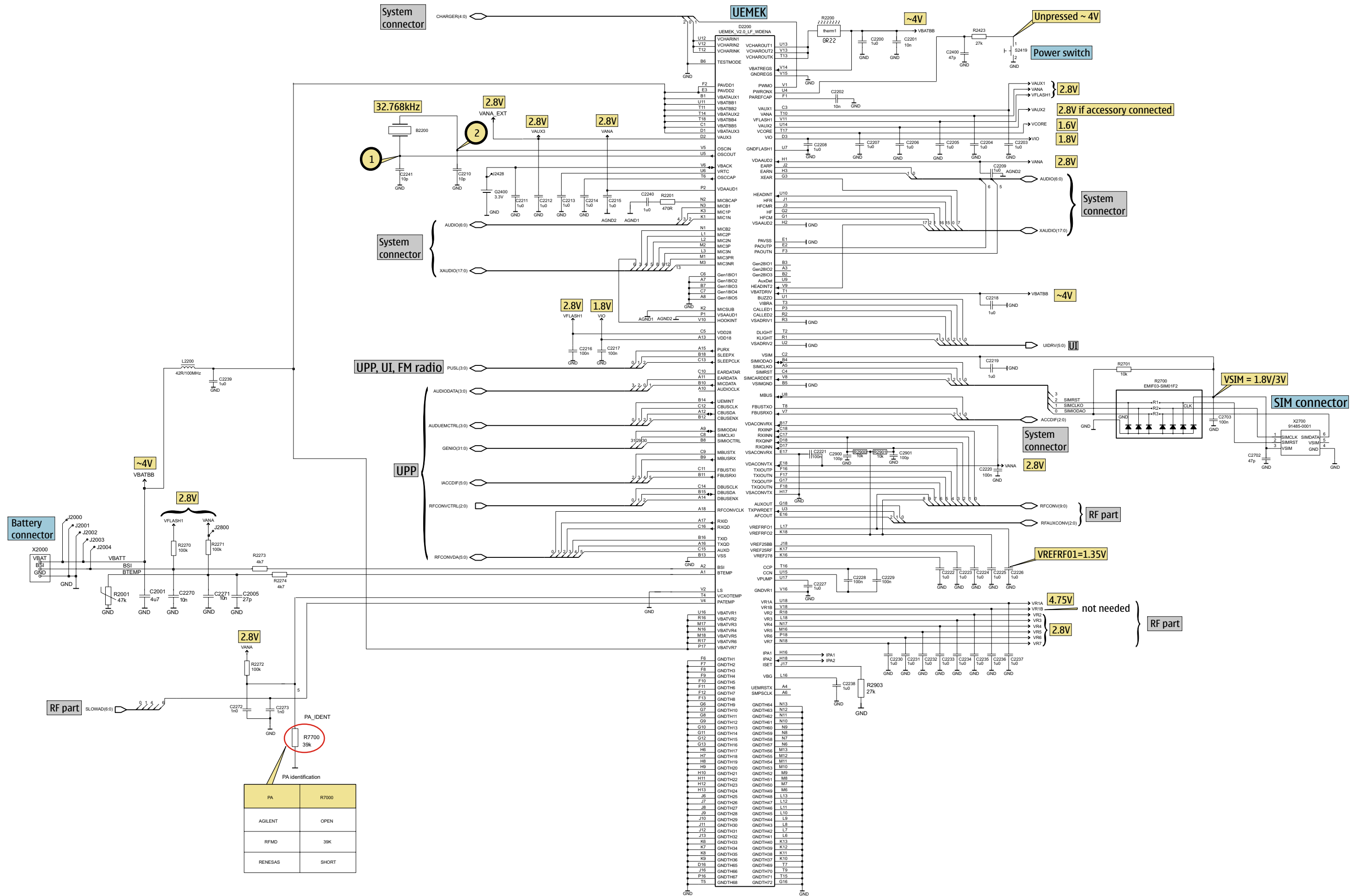

UPP, Combo Memory, IRDA

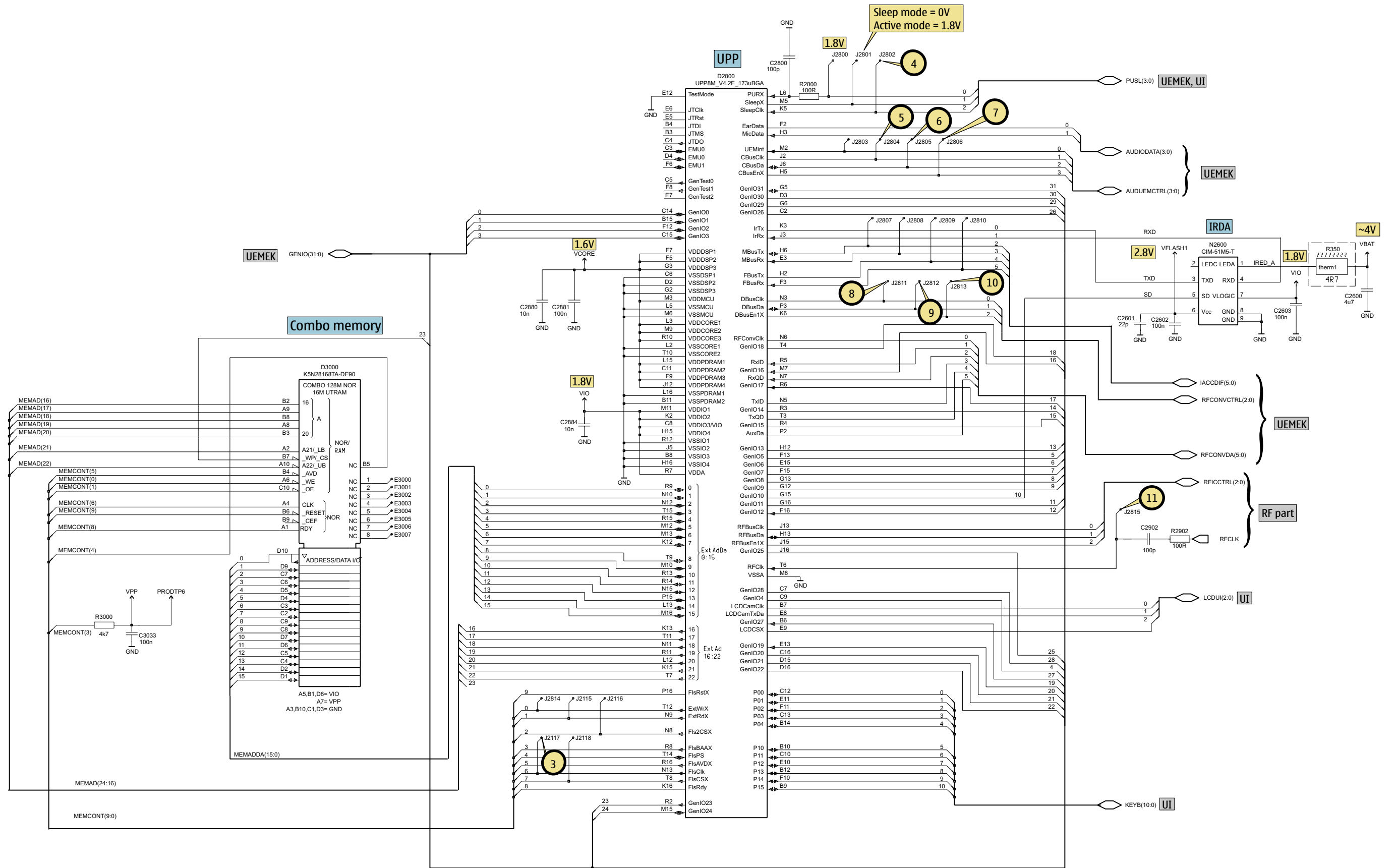

Camera

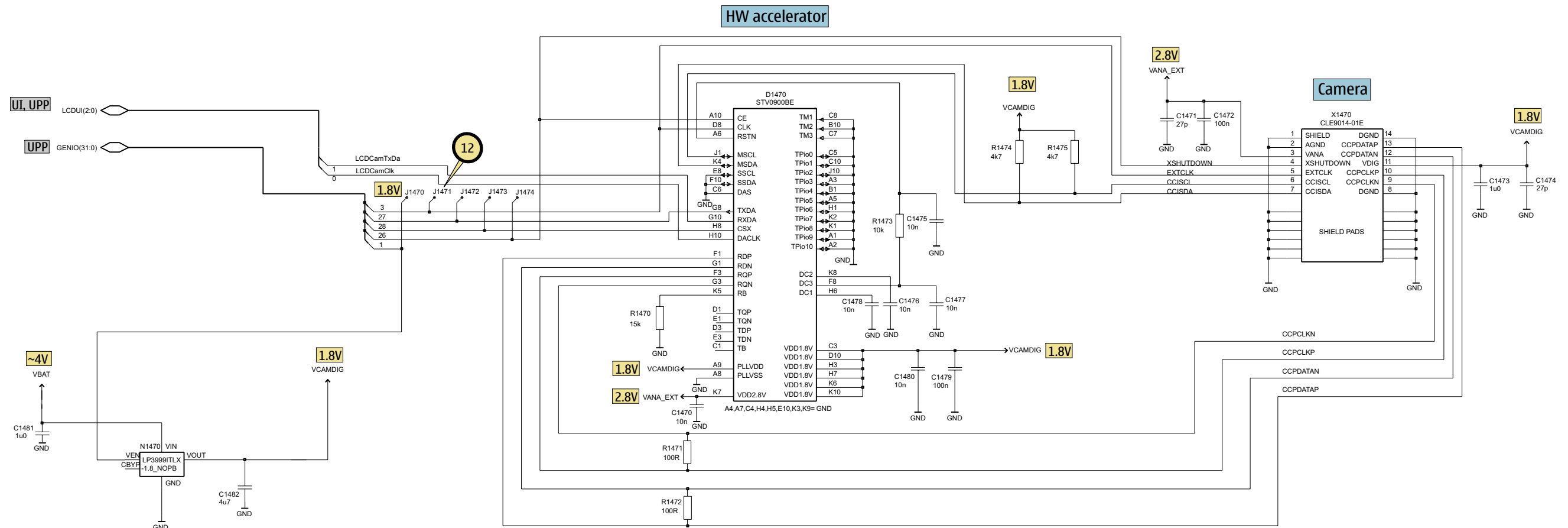

UI, Vibra, Keyboard

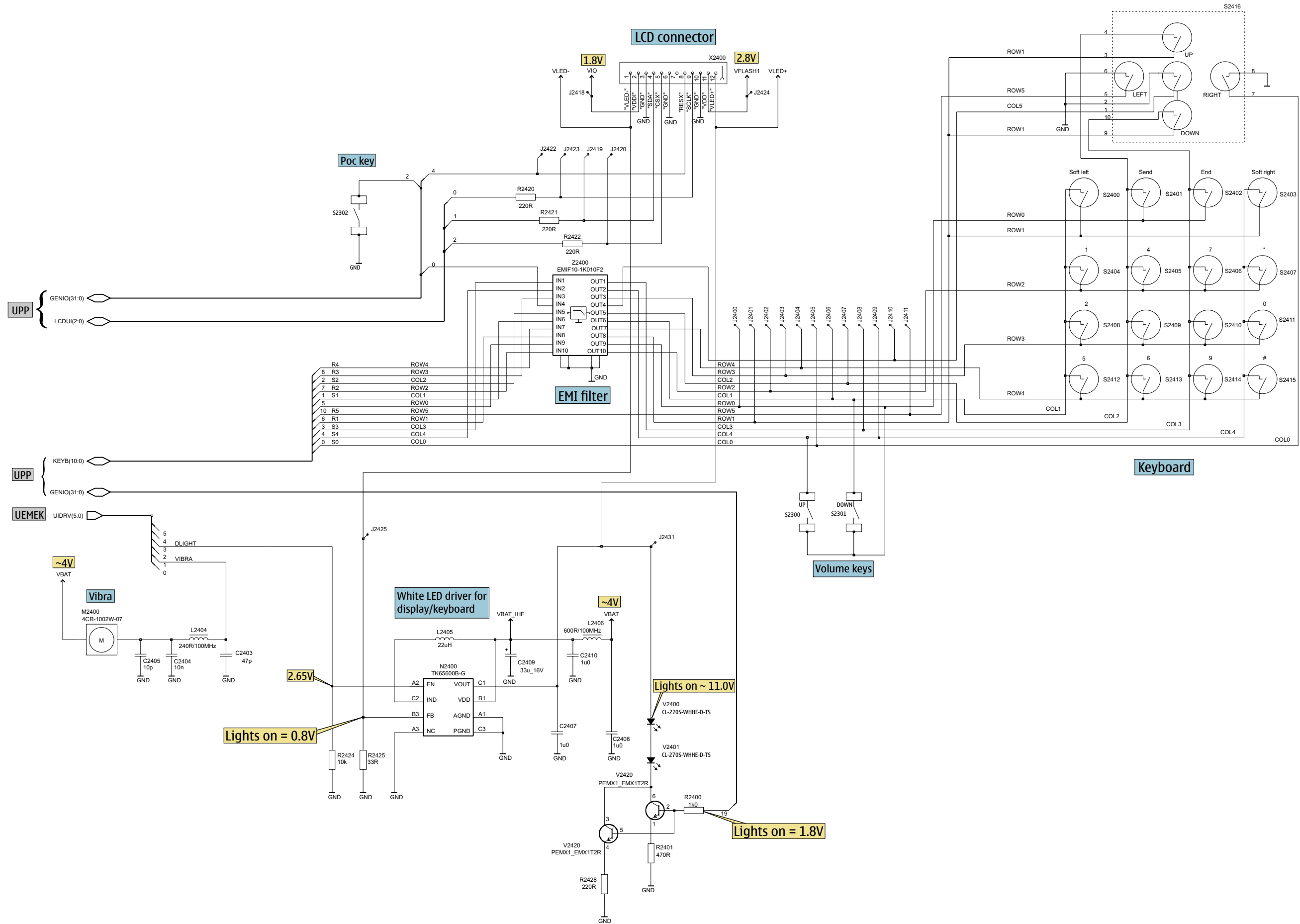

RF Part

VANT_2	VANT_3	VANT_1	RX 1	RX 2	RX 3	TX 1	TX 2
VC1	VC2	VC3	GSM900	GSM1800	GSM1900	GSM900	GSM1800/1900
[Volt]	[Volt]	[Volt]	RX	RX	RX	TX	TX
0	0	0	X				
0	0	0		X			
0	2.6	2.6				X	
0	2.6	0			X		
2.6	2.6	0					X

	C7701	C7709	C7712	C7716	L7702	N7700	R7700	R7701	R7702	R7712	R7713	R7715	R7716	Z7700
EU B0M1	100nF	10nF	na	na	22nH	RFMD PA RF9250 ver.4.1	0R	0R	na	1k	100R	100R	1k	FMD B29J V3.1
EU B0M2	na	na	10nF	10nF	33nH	RFMD PA RF9250 ver.4.1	39k	1k	4k7	na	33R	33R	na	Murata SXS700B1 SAFEK897MFM0F04
EU B0M2B	na	na	10nF	10nF	33nH	RFMD PA RF9250 ver.4.1	39k	1k	4k7	na	33R	33R	na	Murata SXS700B1 SAFEK897MFM0F04
US B0H1	100nF	10nF	na	na	18nH	RFMD PA RF9250 ver.4.1	0R	0R	na	1k	100R	100R	1k	FMD B29J V3.1
US B0M2	1nF	1nF	10nF	10nF	33nH	RFMD PA RF9250 ver.4.1	39k	1k	4k7	na	33R	33R	na	Murata SXS700B1 SAFEK897MFM0F04
US B0M2B	na	na	10nF	10nF	33nH	RFMD PA RF9250 ver.4.1	39k	1k	4k7	na	33R	33R	na	Murata SXS700B1 SAFEK897MFM0F04

Band	Channel	RX	VCO/RX	VC/RX	TX	VCO/TX	VC/TX
EGSM 900	37	942.4MHz	3769.6MHz	~2.73V	897.4MHz	3589.6MHz	~1.99V
GSM 1800	700	1842.8MHz	3685.6MHz	~2.39V	1747.8MHz	3495.6MHz	~1.60V
GSM 1900	661	1960.0MHz	3920.0MHz	~3.31V	1880.0MHz	3760.0MHz	~2.96V

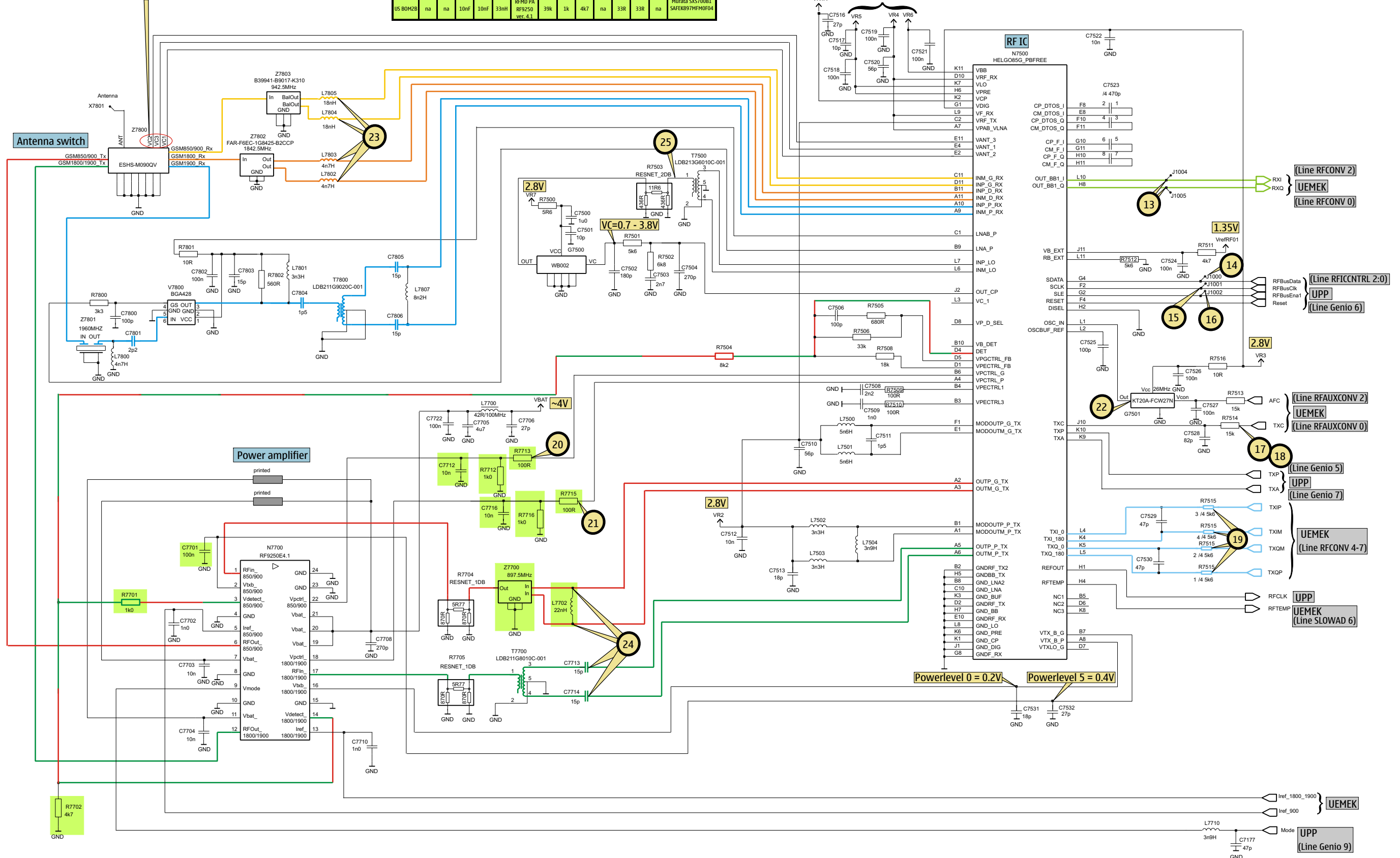

Signal Overview

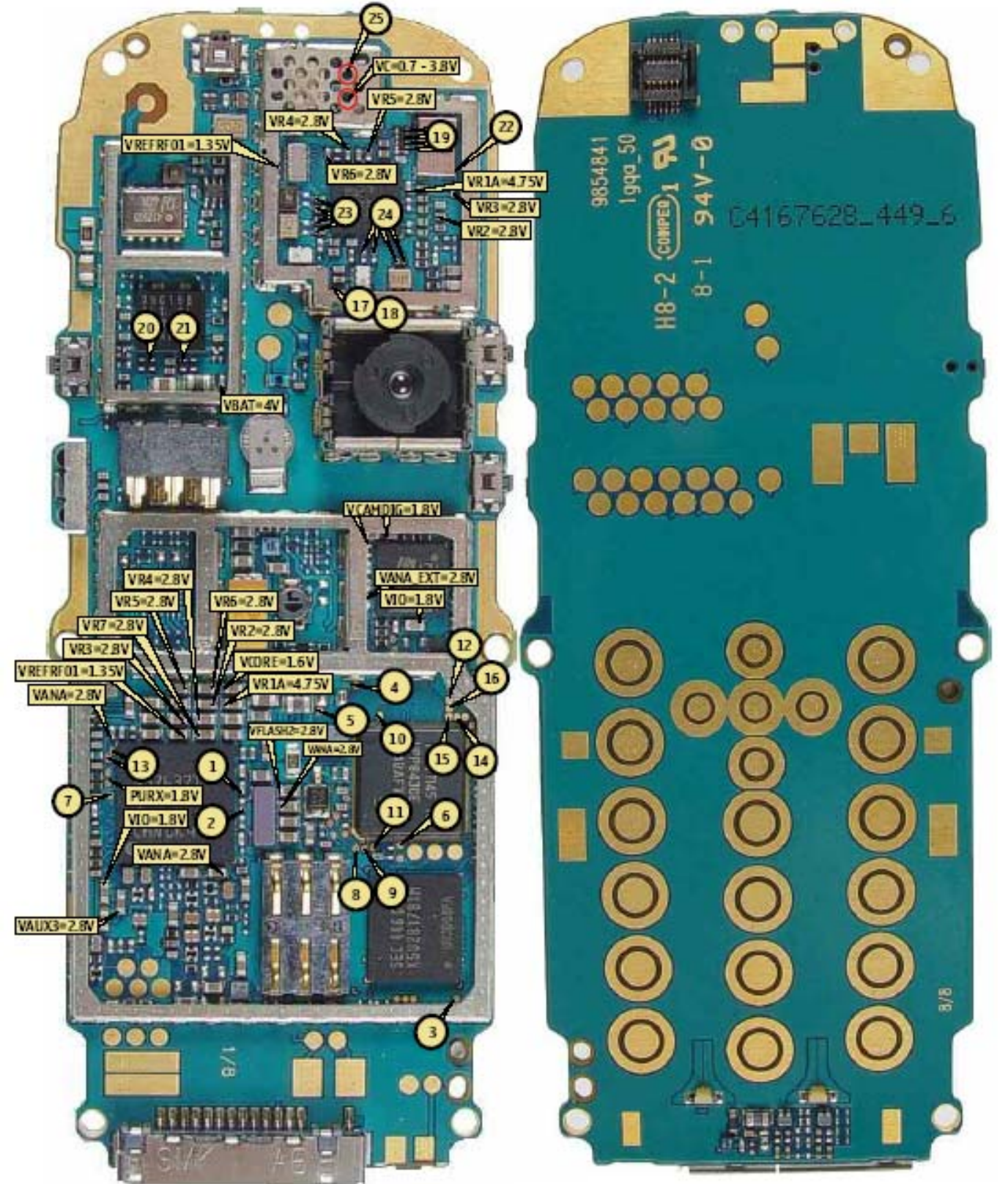
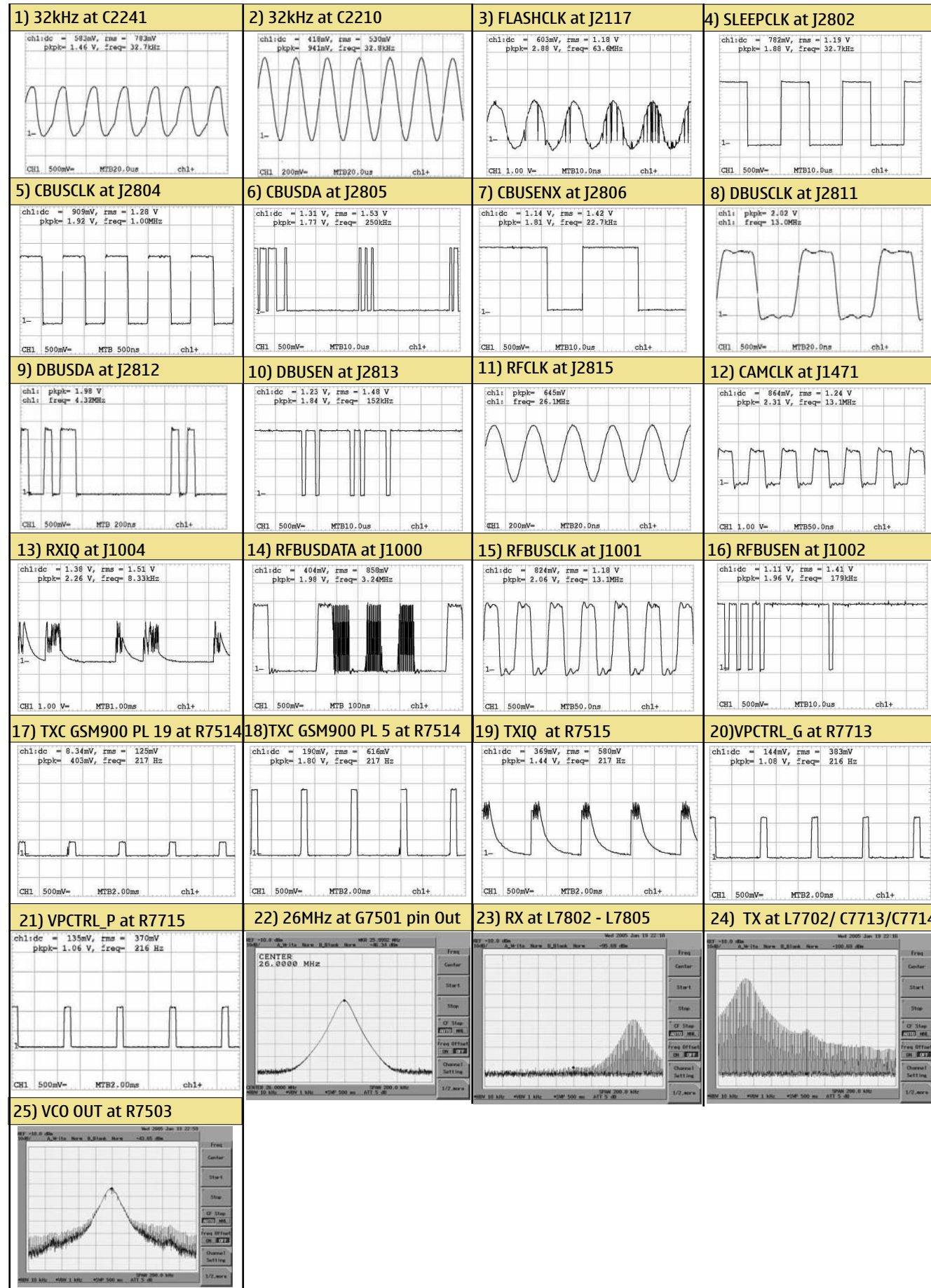

Component Finder

B	C2226	N3	C7527	C7	N7500	E6	R7512	D6	
B2200	05	C2227	N4	C7528	F6	N7700	G3	R7513	C7
B2400	B4	C2228	N4	C7529	D7	R	R7514	F6	
B2401	G4	C2229	N4	C7530	D7	R1470	K6	R7515	E8
B2402	T6	C2230	N4	C7531	F6	R1471	J7	R7516	E8
C	C2231	M4	C7532	F6	R1472	J7	R7700	N2	
C1470	L6	C2232	M3	C7701	G2	R1473	K8	R7702	G4
C1471	K6	C2233	N4	C7702	G2	R1474	K6	R7704	G2
C1472	K6	C2234	N3	C7703	F3	R1475	K6	R7705	G4
C1473	J6	C2235	M4	C7704	F3	R2000	U6	R7710	H2
C1474	J7	C2236	N4	C7705	H3	R2001	O6	R7712	H3
C1475	K8	C2237	M4	C7706	H4	R2002	R2	R7713	H3
C1476	L6	C2238	M3	C7708	H3	R2003	R2	R7715	H3
C1477	L7	C2239	N5	C7709	G4	R2004	R3	R7716	H3
C1478	K6	C2240	P3	C7710	G4	R2005	R2	R7800	D4
C1479	L8	C2241	O4	C7711	G2	R2006	U5	R7801	E4
C1480	L8	C2270	O2	C7713	F6	R2007	U5	R7802	E4
C1481	M8	C2271	P2	C7714	F6	R2010	U4	S	
C1482	L7	C2272	N2	C7800	D4	R2011	U4	S2300	G8
C2001	M5	C2273	P4	C7801	D3	R2151	C4	S2301	J8
C2005	P6	C2400	P4	C7802	E3	R2153	R3	S2302	H1
C2006	U5	C2403	Q3	C7803	E4	R2154	Q3	S2419	B4
C2007	O4	C2404	R2	C7804	F4	R2156	R3	T	
C2008	U5	C2405	R2	C7805	F6	R2158	R4	T7500	C6
C2009	Q2	C2406	C4	C7806	F6	R2159	Q4	T7700	F6
C2011	R2	C2407	K5	D	R2160	Q3	T7800	F5	
C2012	U5	C2408	J4	D1470	K7	R2162	Q4	V	
C2013	U5	C2409	L4	D2200	O3	R2171	R4	V2000	O6
C2020	U4	C2410	K4	D2800	O7	R2173	Q4	V2400	T4
C2021	U4	C2600	F2	D3000	Q7	R2174	P4	V2401	T6
C2154	R3	C2601	J2	F	R2175	Q3	V2420	L5	
C2159	Q3	C2602	J2	F2000	U5	R2200	N5	V7800	E4
C2164	P2	C2603	J2	G	R2201	P3	X		
C2170	Q4	C2702	R6	G2400	I5	R2270	O2	X1470	H7
C2171	Q3	C2703	R6	G7500	C5	R2271	O2	X2000	I3
C2173	Q4	C2800	O6	G7501	D8	R2272	O2	X2002	U4
C2175	R3	C2880	O6	L	R2273	P2	X2060	C4	
C2176	R4	C2881	O6	L2000	T5	R2274	P2	X2400	C6
C2179	Q3	C2884	O6	L2001	T4	R2400	M6	X2700	Q5
C2180	H5	C2900	N2	L2003	T5	R2401	L5	Z	
C2181	P3	C2901	N2	L2004	U5	R2420	L7	Z2400	N6
C2187	Q4	C2902	O8	L2005	U5	R2421	L7	Z7700	F7
C2200	O5	C3033	P7	L2150	C4	R2422	L7	Z7800	E3
C2201	N4	C3180	P8	L2153	Q3	R2423	C4	Z7801	D3
C2202	Q3	C7177	H2	L2154	H5	R2424	J5	Z7802	E5
C2203	Q2	C7500	C5	L2155	G5	R2425	J5	Z7803	E5
C2204	O5	C7501	B5	L2200	M5	R2428	L6		
C2205	O5	C7502	B6	L2404	R2	R2600	E2		
C2206	N5	C7503	B6	L2405	L5	R2700	R4		
C2207	M4	C7504	C6	L2406	K4	R2701	S4		
C2208	Q2	C7506	F8	L7500	E7	R2800	O6		
C2209	Q3	C7508	F8	L7501	E7	R2900	N2		
C2210	O4	C7509	F8	L7502	E7	R2901	N2		
C2211	P5	C7510	E8	L7503	E7	R2902	O8		
C2212	Q2	C7511	E7	L7504	E7	R2903	N2		
C2213	O5	C7512	E8	L7700	H3	R3000	P7		
C2214	P5	C7513	E8	L7702	F7	R3180	P8		
C2215	P4	C7516	D7	L7800	D3	R7500	C5		
C2216	P2	C7517	D6	L7801	E4	R7501	C6		
C2217	O2	C7518	D6	L7802	E6	R7502	B6		
C2218	Q4	C7519	D6	L7803	E6	R7503	C6		
C2219	R4	C7520	E6	L7804	E6	R7504	E7		
C2220	N2	C7521	D6	L7805	E6	R7505	F7		
C2221	N2	C7522	D7	L7807	E6	R7506	F7		
C2222	M3	C7523	D5	N	R7508	E8			
C2223	N3	C7524	D5	N1470	L8	R7509	F7		
C2224	N3	C7525	D7	N2400	K5	R7510	F7		
C2225	M2	C7526	C8	N2600	J1	R7511	D5		

